



POST TYPE PREMIUM WINCH BAR

FITTING INSTRUCTIONS



ISUZU MU-X
2013-2016
PK105SIM13P

Fitting Time : approx. 3 hours



BULL BAR SAFETY NOTICE:

INSTALLATION SHOULD ONLY BE DONE BY APPROPRIATELY QUALIFIED OR EXPERIENCED PERSONS IN ACCORDANCE WITH THESE INSTRUCTIONS.

IT IS THE RESPONSIBILITY OF THE INSTALLER TO ENSURE THAT THE PRODUCT IS CORRECTLY FITTED.

WARNING:

- Do not attach Vehicle Frontal Protection System (**VFPS**) to the vehicle using anchorages not intended for this purpose. (e.g. engine mounting bolts)
- Do not use this product for any vehicle make or model, other than those specified by the VFPS manufacturer.
- Do not remove the plaque or label from the VFPS.
- Do not modify the structure of the VFPS in any way.
- The VFPS has been produced to provide continued functionality of parking sensors and other "driver assist" features as closely as possible to Original Equipment. However, as all possible road conditions and combination of other accessories fitted to the vehicle which may affect functionality characteristics cannot be anticipated, ***the driver remains responsible at all times for properly controlling the vehicle, monitoring all "driver assist" features and intervening where required to ensure the vehicle is safely operated.***

IMPORTANT INFORMATION:

- Before installing the VFPS:
 - Check that all components, as listed in the assembly table, are available.
 - Thoroughly read all instructions.
- This product or its fasteners must not be modified in any way.
- These instructions are accurate as at the revision date and do not take into account any changes made by the vehicle manufacturer to vehicle design after the revision date or other accessories that are or have been fitted to the vehicle. Piak cannot be held responsible for such changes and appropriate enquiries should be made before installation.
- Before installing, inspecting and/or maintaining the VFPS, the work space should be safe and clear of fuel, debris, electrical or other components.
- During installation:
 - It is the responsibility of the installer to confirm correct operation/clearance of all components.
 - All holes drilled shall have all burrs and swarf removed then coated with a suitable rust preventative paint.
 - Ensure that all hardware is fastened to torque list as detailed in these instructions.

MAINTENANCE AND CARE:

To ensure continued safety and correct operation of the product, the VFPS must be routinely inspected and regularly serviced (including bolt torque checked for correct tension) by an appropriately qualified or experienced person.

The high tensile fasteners supplied with this product were used to achieve the specified rating. If replacement of the fasteners is required, fasteners of the same rating and quality must be used.

If this VFPS is fitted with a hinged number plate bracket, extra care must be taken when returning back to public roads following the use of the winch or conducting a deep water crossing.

The driver must ensure that the number plate bracket is returned back to the down position allowing full visibility of the number plate when returning to public roads.

EQUIPMENT:

These safety products should, at a minimum, be used when fitting or working on the product.



Protective Glasses



Hearing Protection

Installation in accordance with these instructions and adherence to warnings will ensure compliance with relevant regulatory and safety standards as at the revision date.

Failure to adhere to these instructions may affect the roadworthiness of the vehicle or cause personal injury, death or damage to property.



BY USING THIS PRODUCT YOU ACKNOWLEDGE AND AGREE THAT TO THE EXTENT PERMITTED BY LAW PIAK WILL NOT ACCEPT LEGAL OR OTHER LIABILITY FOR ANY LOSS, INJURY OR DAMAGE CAUSED BY INCORRECT OR INAPPROPRIATE INSTALLATION OR USE OF THE PRODUCT.









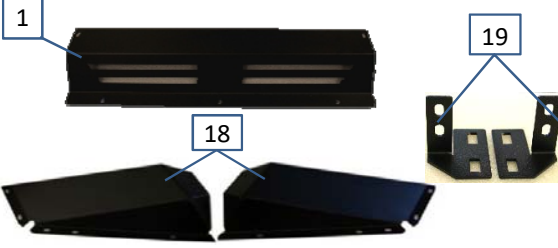

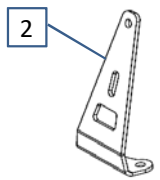
Tools required

1. Metric socket and spanners
2. Phillips and flat head screw driver
3. Torque wrench
4. Marking pen
5. 2" Masking tape
6. Jigsaw
7. Test lamp or multi-meter
8. Drill and metric drill bits

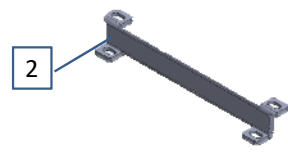
Parts List

⚠ Important : Check contents of fitting kit before commencing fitment and report any discrepancies.

Steel Bull bar			
Item	Component Name	Q'ty	Remarks
1	Winch Bull bar		
Chassis Mounts to Vehicle			
Item	Component Name	Q'ty	Remarks
2	Chassis mounting bracket (RH&LH)	1	
3	Chassis Mount Support Bracket (RH&LH)	2	
4	Hex Bolt M12x35x1.5 Zn	6	
5	Spring Washer M12 Zn	6	
6	Flat Washer M12 Zn	12	
7	Hex Nut M12x1.5 Zn	6	
8	Hex Bolt M10x80x1.5 Zn	4	
9	Hex Bolt M10x35x1.5 Zn	4	
10	Spring Washer M10 Zn	8	
11	Flat Washer M10 Zn	16	
12	Hex Nut M10x1.5 Zn	8	
13	Hex Bolt M8x25x1.25 Zn	4	
14	Spring Washer M8 Zn	4	
15	Flat Washer M8 Zn	8	
16	Flange Nut M8x1.25 Zn	4	
Protection Plates to Bar			
Item	Component Name	Q'ty	Remarks
17	Center Protection Plate	1	
18	Outer Protection Plate (RH&LH)	2	
19	Protection Plate Bracket (RH&LH)	2	
20	Hex Bolt M6x20x1.0 EDP	17	
21	Spring Washer M6 EDP	17	
22	Flat Washer M6 EDP	17	
23	Cage Nut M6x1.0x3T	17	

Winch Control Plate			
Item	Component Name	Q'ty	Remarks
24	Winch Control Plate	1	
25	Hex Bolt M6x20x1.0 Zn 	2	
26	Spring Washer M6 Zn 	2	
27	Flat Washer M6 Zn 	2	
28	Flange Nut M6x1.0 Zn 	2	
License Plate Bracket			
Item	Component Name	Q'ty	Remarks
29	License Plate Bracket	1	
30	Hex Bolt M6x20x1.0 Zn 	4	
31	Spring Washer M6 Zn 	4	
32	Flat Washer M6 Zn 	6	
33	Cage Nut M6x1.0x3T Zn 	2	
34	Flange Nut M6x1.0 Zn 	2	

Torque Setting of Fastener

Mounting bolts must be tightened to torque's specified following ;

Bolt Diameter (mm.)	Torque (Nm)	Torque (ft.lb)
M6	9	7
M8	22	16
M10	44	32
M12	77	57

Fitting Procedure



1 Locate the vehicle in a suitable position.

2 Rest the bullbar on a surface that will not scratch the bar.



3 Remove four clips that retain the grille at the top. Keep for re-fitment of grille.



4 Remove one screw that retain the grille at the front. Keep for re-fitment of grille.



5 Remove the front grille and keep for re-fitment.

Fitting Procedure

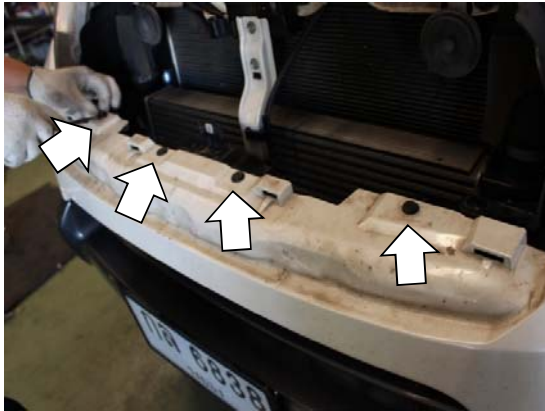

- 6 Remove and discard four clips that retain the bumper at the top.



- 7 Remove and discard two original nuts that retain the bumper at the bottom.



- 8 Remove and discard the screw retaining the bumper bar in the wheel arch.

- 9 Repeat for the opposite side.



- 10 Carefully remove the bumper from the vehicle.

If unsure about bumper removal refer to the workshop manual.

Fitting Procedure

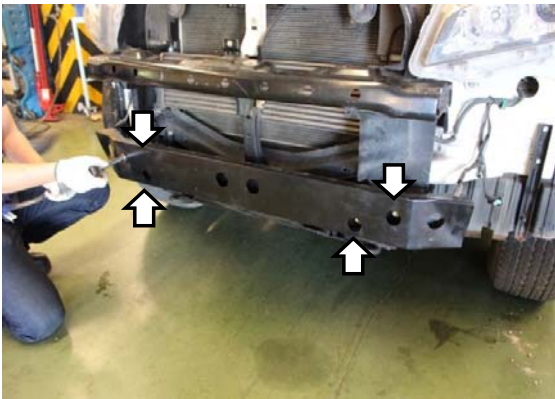

- 11** Remove and retain four original bolts from the front intrusion beam for re-fitment.

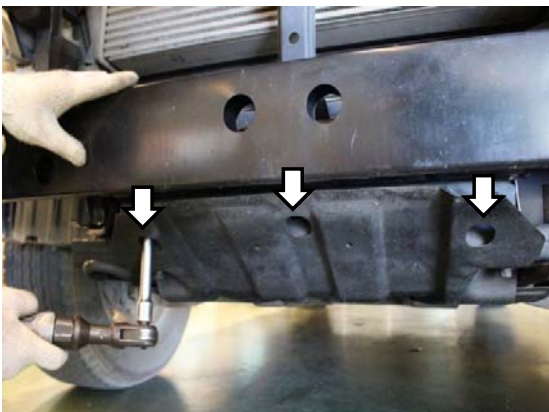

- 12** Remove and discard three original bolts from the lower plastic stone tray .



- 13** Remove and discard the front intrusion beam from the vehicle.



- 14** Remove and discard the bumper clips from the lower edge of the headlights.

Fitting Procedure



- 15** Remove and discard the outer bumper clips from the front guards.
- 16** Repeat in step 14-15 for the opposite side.



- 17** Lift the chassis mounting bracket onto the chassis of vehicle.

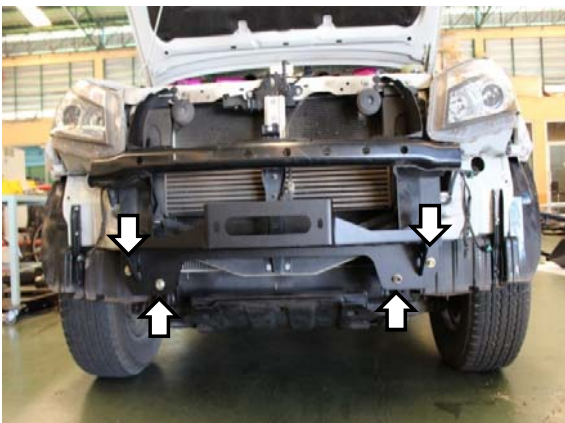

- 18** Secure with four original bolts removed earlier to the mounting bracket as indicator.

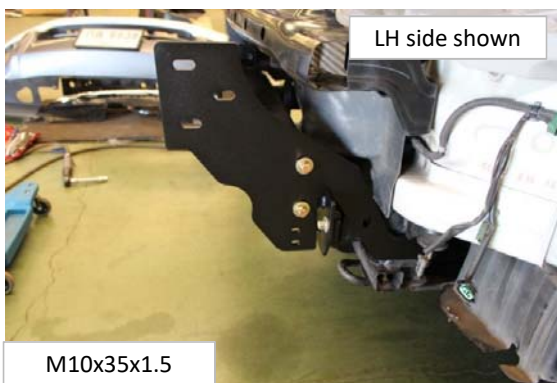

- 19** Fit the chassis mount support bracket to the mounting bracket by using two M10 bolts (M10x35x1.5), spring washers, flat washers and hex nuts.

Fitting Procedure

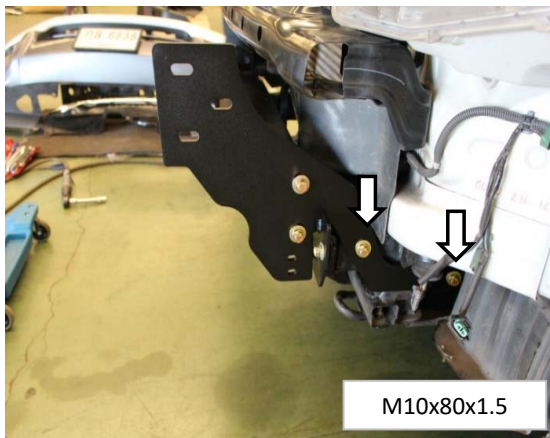

- 20** Secure with two M10 bolts (M10x80x1.5), spring washers, flat washers and hex nuts as indicators.

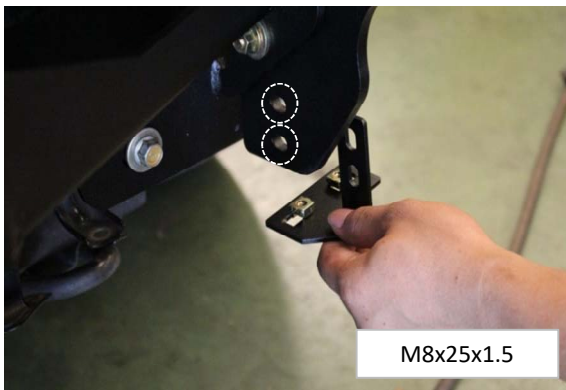

- 21** Insert two cage nuts (3 mm.) to the protection plate bracket and fit to the mounting support bracket by using two M8 bolts (M8x25x1.25) spring washers, flat washers and flange nuts.



- 22** Trim the inner guard as shown.

- 23** Repeat in step 19-22 for the opposite side.

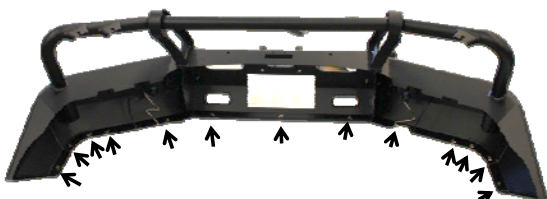

- 24** Insert thirteen M6 cage nuts (3 mm.) onto the bullbar as indicators.

Fitting Procedure



- 25** Lift the bullbar onto the chassis of the vehicle.

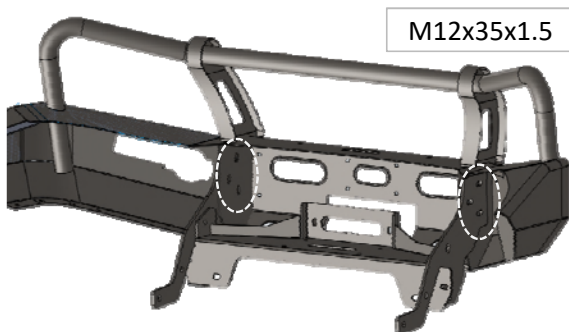

- 26** Secure bull bar onto the chassis mounting bracket by using three M12 bolts (M12x35x1.5), spring and flat washers and hex nuts as shown at the circles.

- 27** Repeat for the opposite side.



- 28** Fit center protection plate onto the bullbar by using three M6 bolts (M6x20x1.0), spring washers and flat washers.



- 29** Fit outer protection plate onto the bullbar by using five M6 bolts (M6x20x1.0), spring washers and flat washers.

Fitting Procedure

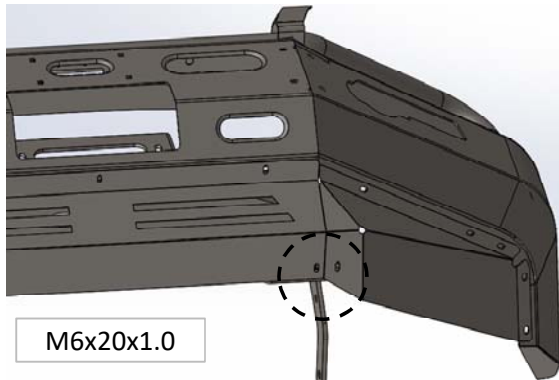

30 Fit outer protection plate onto the center protection plate by using two M6 bolts (M6x20x1.0), spring washers and flat washers.

31 Repeat in step 29-30 for the opposite side.



32 Re-install the front grill removed earlier to the vehicle by using four clips and one screw for re-fitment.

