

THE POWER OF

REDARC®

Single Voltage 52mm Gauge

(with Optional Current Display)*

G52-VA

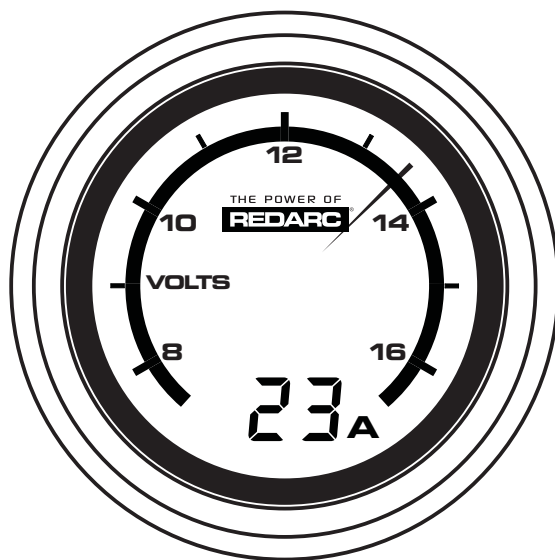

*Optional Current Display requires the purchase of GS-AMPS



WARNING & SAFETY INSTRUCTIONS

SAVE THESE INSTRUCTIONS - This manual contains IMPORTANT SAFETY INSTRUCTIONS for the G52-VA Gauge.

DO NOT OPERATE THE GAUGE UNLESS YOU HAVE READ AND UNDERSTOOD THIS MANUAL AND THE GAUGE IS INSTALLED AS PER THESE INSTALLATION INSTRUCTIONS. NOT SUITABLE FOR MARINE APPLICATIONS.

NOTICE

1. The G52-VA Single Voltage Gauge is designed to provide an accurate indication of Voltage and an optional current indication. As accurate as the indication might be, these gauges are not designed to be a substitute for regular maintenance and inspection by a qualified technician.
2. REDARC recommend that the G52-VA Single Voltage Gauge be installed by a qualified technician.
3. Ensure the gauge face is cleaned only using soapy water and a soft cloth.
4. REDARC gauges are not suitable for installation into marine environments.

SPECIFICATIONS

	G52-VA
Input Voltage Range	6 - 16V (For 24V systems use GA-2412V)
Nominal Current Draw	30mA
Gauge Dimensions	Ø52mm x 42mm (not incl. studs, Bezel Ø56mm)
Gauge Weight	50g
Warranty	2 Years
Sensor 1	Voltage
Sensor 2 (optional)	Current (Amps)

PRODUCT FUNCTION

The G52-VA is designed to measure a voltage level. The voltage is indicated on a 270° sweep gauge indicating between 7.5V and 16.5V.

The G52-VA also features an optional current (Amps) meter for which a separate sensor is required*. The Current is displayed on the digital readout at the bottom of the gauge and is capable of measuring up to 100A.

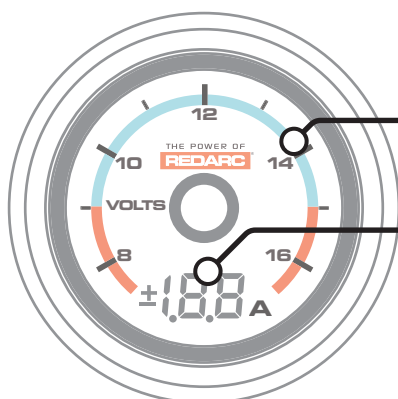

Voltage Gauge
270° Sweep
7.5 - 16.5V

Current Gauge
Digital
0-100A

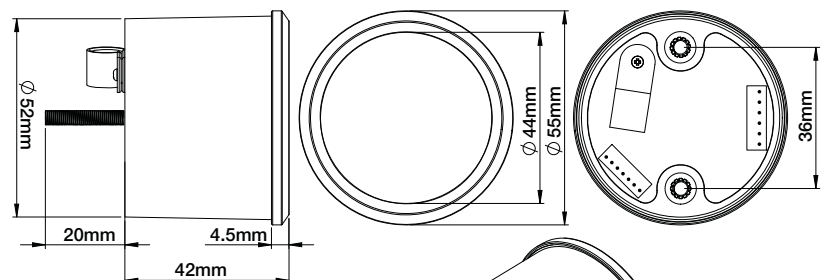

Ensure that 'P'-Clip and star washers are used during installation.

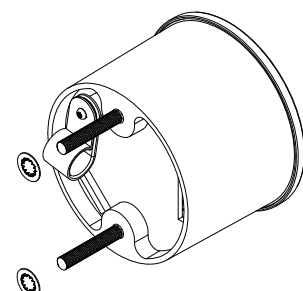

*GS-AMPS

INSTALLATION

Find a suitable location for mounting the Gauge. REDARC offer a range of mounting solutions - refer to www.redarc.com.au. It is important to ensure that your installation meets any regulations regarding Field of View and Head Impact requirements.

Wire into vehicle as per the diagram below:

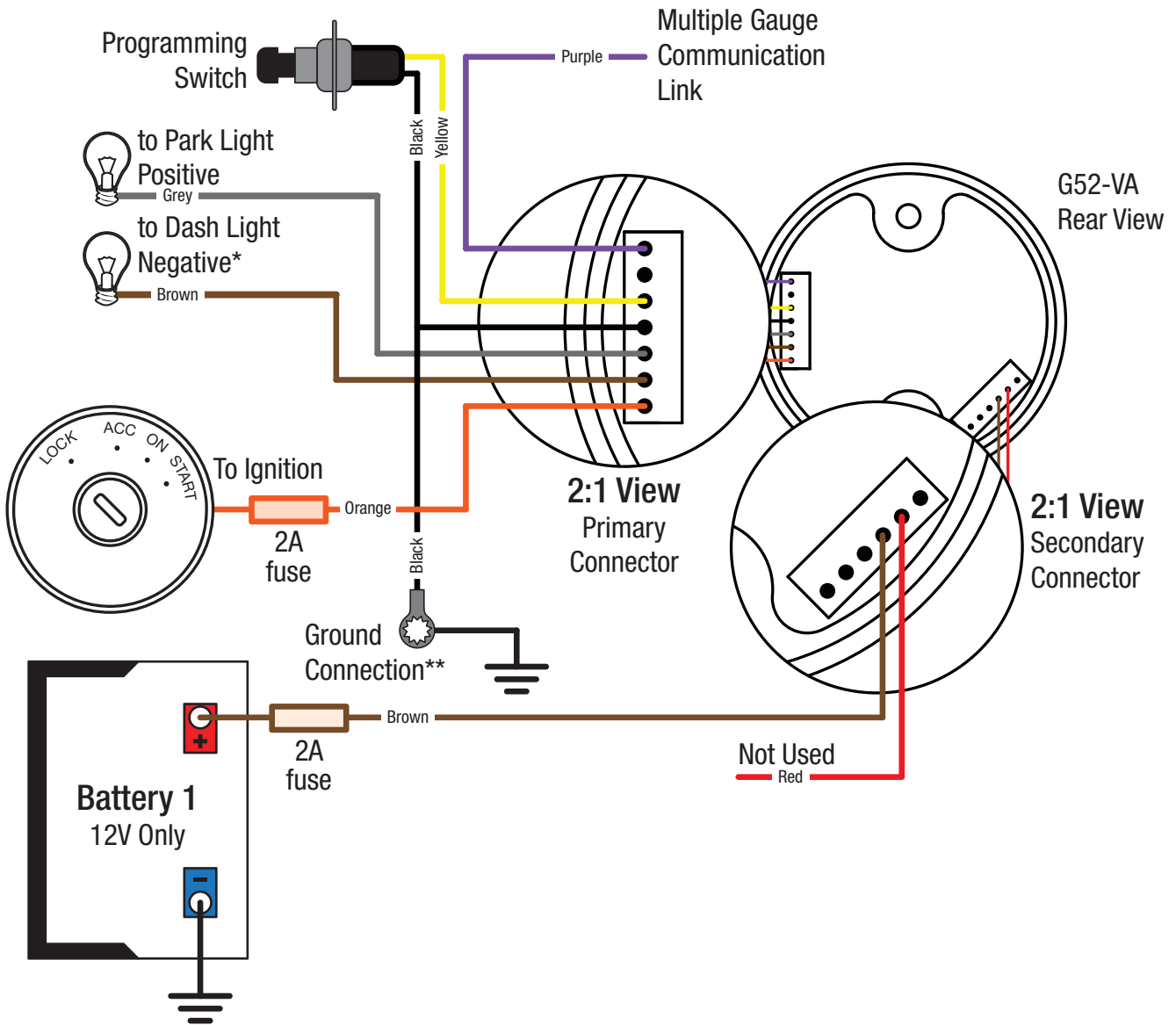

* Connect to a dash light that dims via the vehicle dimmer adjustment to ensure the gauge dims accordingly. If your illumination circuit in your vehicle varies the positive voltage for dimming you will require an Redarc Enhanced Lighting Controller (GA-ELC) to get the gauge to dim with your night-time driving lights.

** Ensure that the ground connection makes good contact with the vehicle ground. Poor grounding can cause incorrect sensor readings. REDARC recommend removing any paint from the surface to ensure a bare metal on metal connection. It is recommended that any wiring harnesses be covered using conduit or similar.

OPERATING INSTRUCTIONS

Selecting Gauge ID for multi-gauge systems

If your gauge is part of a multi gauge system (i.e. more than one gauge) and you wish to allow programming from a single push button, connect the communication link wires together (see wiring diagram on page 2). The Gauge "Id" of all linked gauges will need to be set to unique numbers. Make sure that each gauge is set to a unique number or letter and that one gauge is set as the master "Id.0". The master gauge switch needs to be accessible for programming all the gauges. Each individual gauge switch is only needed to set the programming ID.

Setup Instructions

Setup Mode is only required if you wish to change settings such as background color or other options. Setup mode is indicated by the display of the programming symbol. 

A detailed listing of the Setup Modes for the G52-VA can be found on page 5.

To enter Setup Mode:

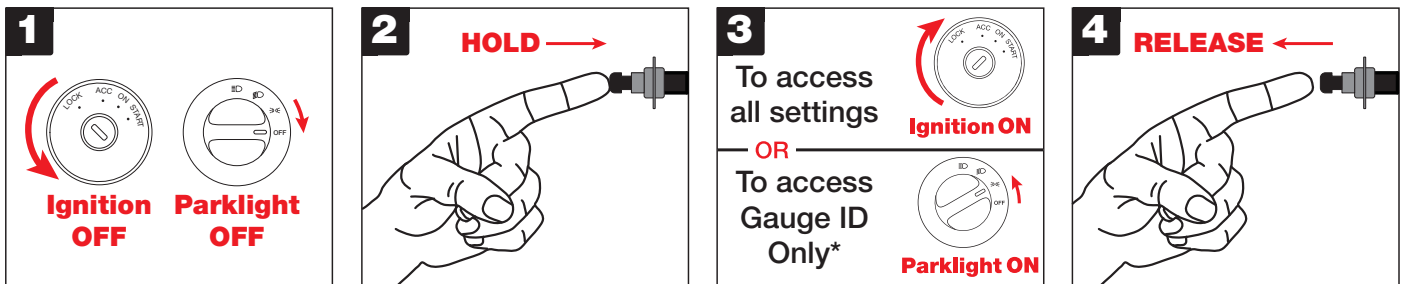

To view the next setting:

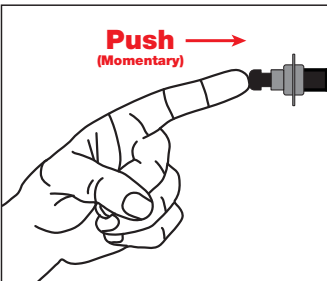

To change the setting & move to next mode:

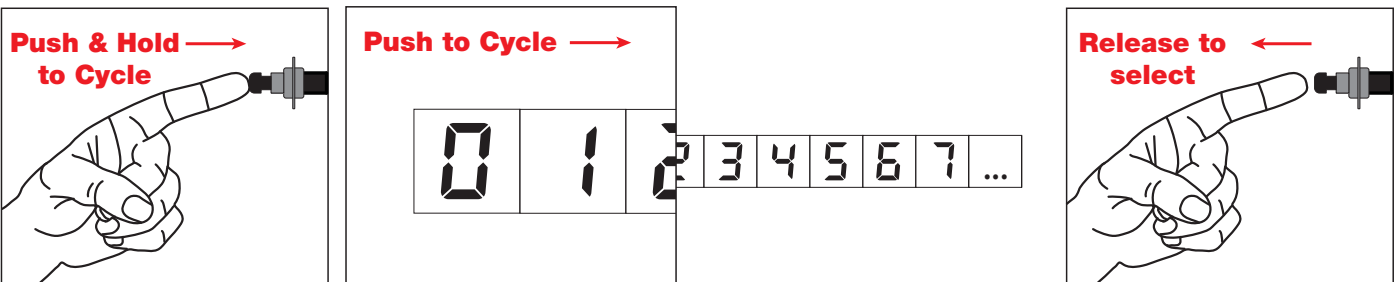

To save all changes:

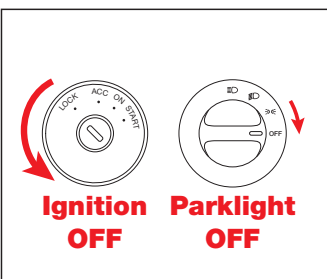

FREQUENTLY ASKED QUESTIONS

I cannot get the relay output feature to work.

The G52-VA and G52-VVA is not equipped with a relay output feature. All other gauges within the range include this feature.

I cannot get the 'peak hold' feature to work.

The G52-VA and G52-VVA is not equipped with the peak hold feature. All other gauges within the range include this feature.

Do I need to purchase the optional sensor for my gauge to work?

No, the standard features of the gauge will still work. To purchase the optional sensors please visit www.redarc.com.au

What is the P-clip used for?

Attaching the p-clip to the back of the gauge ensures that the connectors are strongly fixed to the gauge, thereby minimising the risk that they may come loose during installation and/ or rough driving conditions.

I cannot see my question here?

Please contact REDARC's free technical support on (08) 8322 4848

Is the gauge compatible with existing vehicle sensors or other sensors available in the market?

No, the gauge is designed to work only with the sensors sold by REDARC.

What is the best mounting solution for my gauge?

REDARC offers a range of mounting panels and a mounting cup for its gauge range. Please ensure that fitment of your gauge does not impede your driving field of view or create a head impact hazard.

Should I enclose the wiring harnesses in conduit?

REDARC recommends enclosing the supplied wiring harnesses in a suitable conduit that will protect the wiring against sharp edges and/ or extreme temperatures.

Where should I install the black push button?

In most cases, once the gauge is set up and programmed the push button can be hidden behind the vehicles instrument dash panel. However, if you believe that you may need to regularly change any of the modes you should locate the push button in an accessible area (e.g. at the back of the mounting cup).

Can I fit my gauge to a 24V vehicle circuit?

The gauge requires 12V to operate. A 24V to 12V adaptor is available for purchase (GA-2412V). This can be purchased for all gauges, however the G52-VA and G52-VVA will only allow you to monitor the charging performance of 12V batteries.

My gauge is too bright when driving (i.e. at night), what should i do?

You will need to purchase an Enhanced Lighting Controller (GA-ELC). This module is to be used when you do not have a dimming circuit you can connect your gauges to, are using REDARC Gauges for all of your instrumentation so require dimming or the dimming circuit in your vehicle does not dim the REDARC gauges to your liking. The ELC allows you to program the night time brightness and colour of your gauges, including dimming if connected to a dash dimmer (i.e. once programmed your gauge(s) will change colour when turning on your park lights and back to a day light colour when you turn them off). You only require one ELC for a complete set of gauges. It can be used in conjunction with the 24 volt adaptor (GA-2412V) for a 24 volt system (ELC module is 24V capable).

OPERATING INSTRUCTIONS

Setup Modes (Setup mode is indicated by display of the programming symbol)

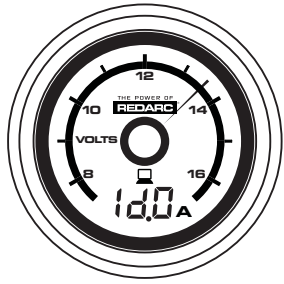

ID Select

Mode / Beeps: 1

Selections: 0 to 9 & A to F (16 selections)

For a single gauge setup do not change this selection as only the default selection 'Id.0' allows programming of modes.

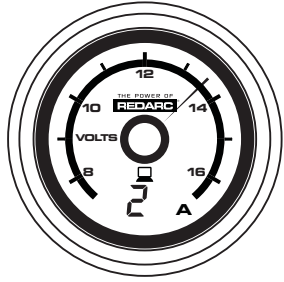

Background Colour

Mode / Beeps: 2

Selections: 13 colours

Press and hold to select the programming button to select the colour that the gauge backlight will display during normal operation. There are 13 different colour options.

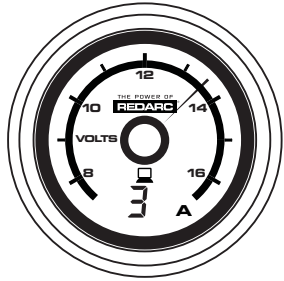

Alert Colour

Mode / Beeps: 3

Selections: 2 Colours (Amber & Red)

Press and hold the programming button to select the colour that the gauge backlight will change to when an alert is indicated (such as during a low voltage warning).

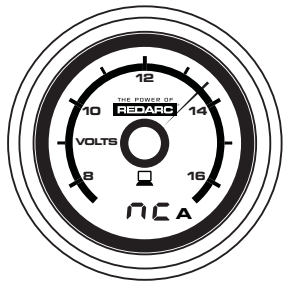

Current Sensor Display

Mode / Beeps: 4

Selections: '0.0' or 'nc'

CHANGING THIS SETTING FROM 'NC' TO 0.0 WILL RESET THE ZERO-OFFSET OF THE CURRENT METER. ENSURE THAT NO CURRENT IS FLOWING WHILST CHANGING THIS SETTING.

If you have installed the optional current sensor (GS-AMPS) and wish to display current, set this to '0.0', otherwise set to 'nc'.

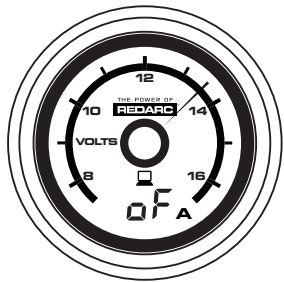

Not Used

Mode / Beeps: 5

Selections: '0F'

Not used on this model.

TWO YEAR PRODUCT WARRANTY

Over the last three decades our company has established a reputation as the power conversion specialist.

A 100% Australian-owned company, we have met the needs of customers in transport and other industries through exciting, innovative thinking.

We believe in total customer satisfaction and practice this by offering our customers:

- Technical advice free of jargon and free of charge
- Prompt turnaround of orders throughout Australia and globally
- Friendly, personalised, professional service and product support

In the unlikely event that a technical issue arises with a Redarc product, customers are encouraged to initially contact the Redarc Technical Support Team on (08) 8322 4848 or power@redarc.com.au for prompt and efficient diagnosis and product support.

Our goods come with guarantees that cannot be excluded under the Australian Consumer Law. You are entitled to a replacement or refund for a major failure and compensation for any other reasonably foreseeable loss or damage. You are also entitled to have the goods repaired or replaced if the goods fail to be of acceptable quality and the failure does not amount to a major failure.

The benefits of this Warranty are in addition to other rights and remedies available at law in respect of the Products and shall not derogate from any applicable mandatory statutory provisions or rights under the Australian Consumer Law.

Redarc Electronics Pty Ltd at the Redarc Trust trading as Redarc Electronics ("**Redarc**") offers a warranty in respect of its Products where the Products are purchased from an authorised distributor or reseller of Redarc by a person ("**Purchaser**"), on the terms and conditions, and for the duration, outlined below in this document ("**Warranty**").

1. In this Warranty, the term **Products** means:
 - 1.1 all products manufactured or supplied by Redarc (excluding its solar products which are covered by Redarc's Solar Product Warranty); and
 - 1.2 any component of or accessory for any product in clause 1.1 manufactured or supplied by Redarc.

Offer and duration of product warranties

2. Redarc warrants that its Products will be free, under normal application, installation, use and service conditions, from defects in materials and workmanship affecting normal use, for **2 years** from the date of purchase (**Warranty Period**).
3. Where a Product malfunctions or becomes inoperative during the Warranty Period, due to a defect in materials or workmanship, as determined by Redarc, then subject to further rights conferred by the Australian Consumer Law on the Purchaser, Redarc will, in exercise of its sole discretion, either:
 - 3.1 repair the defective Product;
 - 3.2 replace the defective Product; or
 - 3.3 provide a refund to the Purchaser for the purchase price paid for the defective Product, without charge to the Purchaser.
4. The warranty given by Redarc in clause 3 covers the reasonable costs of delivery and installation of any repaired or replaced Products or components of Products to the Purchaser's usual residential address notified to Redarc, together with the reasonable costs of removal and return of any Products determined by Redarc to be defective.
5. If the Purchaser incurs expenses of the nature referred to in clause 4 in the context of making a claim pursuant to this Warranty that is accepted by Redarc, the Purchaser will be entitled to claim for reimbursement of those expenses which Redarc determines, in exercise of its sole discretion, to be reasonably incurred, provided that the claim is notified to Redarc in writing at the postal address or email address specified in clause 21 and includes:
 - 5.1 details of the relevant expenses incurred by the Purchaser; and
 - 5.2 proof of the relevant expenses having been incurred by the Purchaser.

Exclusions and limitations

6. This Warranty will not apply to, or include any defect, damage, fault, failure or malfunction of a Product, which Redarc determines, in exercise of its sole discretion, to be due to:
 - 6.1 normal wear and tear or exposure to weather conditions over time;
 - 6.2 accident, misuse, abuse, negligence, vandalism, alteration or modification;
 - 6.3 non-observance of any of the instructions supplied by Redarc, including instructions concerning installation, configuring, connecting, commissioning, use or application of the Product, including without limitation choice of location;
 - 6.4 failure to ensure proper maintenance of the Product strictly in accordance with Redarc's instructions or failure to ensure proper maintenance of any associated equipment or machinery;
 - 6.5 repairs to the Product that are not strictly in accordance with Redarc's instructions;
 - 6.6 installation, repairs or maintenance of the Product by, or under the supervision of, a person who is not a qualified auto electrician or technician, or if non-genuine or non-approved parts have been fitted;
 - 6.7 faulty power supply, power failure, electrical spikes or surges, lightning, flood, storm, hail, extreme heat, fire or other occurrence outside the control of Redarc;
 - 6.8 use other than for any reasonable purpose for which the Product was manufactured;
 - 6.9 any indirect or incidental damage of whatever nature outside the control of Redarc.
7. Warranty claims in respect of a Product must be made in writing to Redarc at the postal address or email address specified in clause 21 within the Warranty Period. Such claims must include the following:
 - 7.1 details of the alleged defect or fault and the circumstances surrounding the defect or fault;
 - 7.2 evidence of the claim, including photographs of the Product (where the subject of the claim is capable of being photographed);
 - 7.3 the serial number of the Product, specified on the label affixed to the Product; and
 - 7.4 proof of purchase documentation for the Product from an authorised distributor or reseller of Redarc, which clearly shows the date and place of purchase.The return of any Products without the prior written instructions of Redarc will not be accepted by Redarc.

8. Without limiting any other clause in this Warranty, Redarc has the right to reject any Warranty claim made by a Purchaser pursuant to this Warranty where:
 - 8.1 the Purchaser does not notify Redarc in writing of a Warranty claim within the Warranty Period;
 - 8.2 the Purchaser does not notify Redarc in writing of a Warranty claim within 1 month of becoming aware of the relevant circumstances giving rise to the claim, so that any further problems with the Product are minimised;
 - 8.3 the serial number of the Product has been altered, removed or made illegible without the written authority of Redarc;
 - 8.4 the Purchaser is unable to provide proof of purchase documentation in accordance with clause 7.4 or evidence that the Product was properly installed and removed (if relevant), and that proper maintenance has been performed on the Product, by, or under the supervision of, a qualified auto electrician or technician, in accordance with the instructions of Redarc.
9. If the Product is found to be working satisfactorily on return to Redarc or upon investigation by Redarc, the Purchaser must pay Redarc's reasonable costs of testing and investigating the Product in addition to shipping and transportation charges. Where Redarc is in possession of the Product, the Product will be returned to the Purchaser on receipt of the amount charged.
10. Any replaced Products or components of Products shall become the property of Redarc.
11. Redarc may, in exercise of its sole discretion, deliver another type of Product or component of a Product (different in size, colour, shape, weight, brand and/or other specifications) in fulfilling its obligations under this Warranty, in the event that Redarc has discontinued manufacturing or supplying the relevant Product or component at the time of the Warranty claim, or where such Product or component is superior to that originally purchased by the Purchaser.

Other conditions of Warranty

12. If the Purchaser acquired a Product for the purpose of resupply, then this Warranty shall not apply to that Product.
13. In particular, the sale of a Product via an online auction, online store or other internet website by a party that is not an authorised distributor or reseller of the Product will be deemed to be a resupply within the meaning of the Australian Consumer Law and will render this Warranty void, as Redarc has no control over the storage, handling, quality or safety of Products sold by such persons.
14. A Purchaser shall only be entitled to the benefit of this Warranty after all amounts owing in respect of the Product have been paid.
15. While Redarc warrants that the Products will be free from defects in materials and workmanship in the circumstances set out in this Warranty, to the maximum extent permitted by law Redarc does not warrant that the operation of the Products will be uninterrupted or error-free.
16. To the maximum extent permitted by law, Redarc's determination of the existence of any defect and the cause of any defect will be conclusive.
17. Spare parts or materials for the Products are guaranteed to be available for a period of at least 2 years after purchase of the Products.
18. The agents, officers and employees of any distributor or reseller of the Products and of Redarc are not authorised to vary or extend the terms of this Warranty.
19. Redarc shall not be responsible or liable to the Customer or any third party in connection with any non-performance or delay in performance of any terms and conditions of this Warranty, due to acts of God, war, riots, strikes, warlike conditions, plague or other epidemic, fire, flood, blizzard, hurricane, changes of public policies, terrorism and other events which are beyond the control of Redarc. In such circumstances, Redarc may suspend performance of this Warranty without liability for the period of the delay reasonably attributable to such causes.
20. If a clause or part of a clause in this Warranty can be read in a way that makes it illegal, unenforceable or invalid, but can also be read in a way that makes it legal, enforceable and valid, it must be read in the latter way. If any clause or part of a clause in this Warranty is illegal, unenforceable or invalid, that clause or part is to be treated as removed from this Warranty, but the rest of this Warranty is not affected.

Redarc's contact details

21. Redarc's contact details for the sending of Warranty claims under this Warranty are:

Redarc Electronics Pty Ltd
23 Brodie Road (North), Lonsdale SA 5160
Email: power@redarc.com.au
Telephone: +61 8 8322 4848

Copyright © 2014 Redarc Electronics Pty Ltd. All rights reserved.

Whilst all care was taken to ensure the contents of this manual were accurate at the time of printing, we take no responsibility for any errors or omissions.